

CKD FRL Basic Components Chart

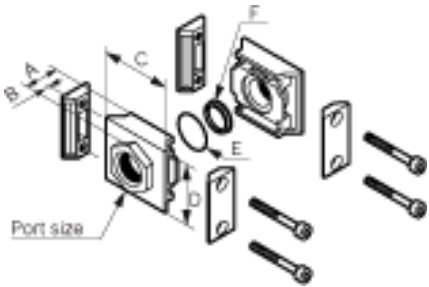

**A100-(6,8,10)-W
Straight End Plate Kit**

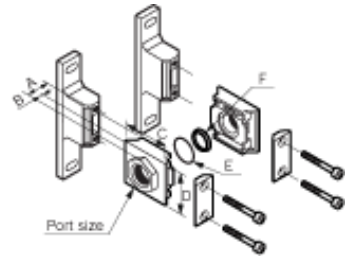

**A100-(6,8,10)-W-B11W
Straight end Plate Kit**

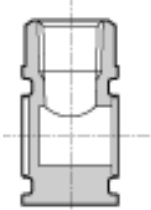

**A101-(6,8,10)-W- B11W
90° entry end port**

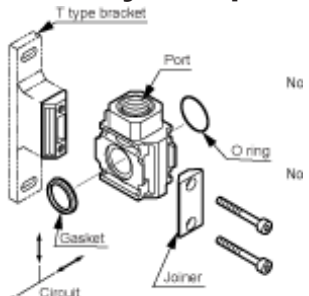

**D101-(6,8,10)-W-B11W
Distributor Block**



V1000 Shut Off

1000 Series Components Options

- A100-(6,8,10)-W end plate port set (1/8, 1/4, or 3/8 ports)
- *[B110-W Wall mount Joiner Plate](#)
- *[C1000-J100-W Plain Joiner plate](#)
- *[D101-00-\(6 or 8\)-W-B11W 1/8 or 1/4 RPT Dist Block](#)
- Shut Off Valve
- V1000-(6,8)-W Rpt Manual shut off valve(1/8 or 1/4 ports)
- *[B110-W Wall mount Joiner Plate](#)
- *[C1000-J100-W Plain Joiner plate](#)
- *[D101-00-\(6 or 8\)-W-B11W 1/8 or 1/4 RPT Dist Block](#)
- Filter
- F1000-(8,10)-W Filter(1/8 or 1/4 ports)
- *[B110-W Wall mount Joiner Plate](#)
- *[C1000-J100-W Plain Joiner plate](#)
- *[D101-00-\(6 or 8\)-W-B11W 1/8 or 1/4 RPT Dist Block](#)
- Regulator
- R1000-(6,8)-W Regulator (1/8 or 1/4 ports)
- *[B110-W Wall mount Joiner Plate](#)
- *[C1000-J100-W Plain Joiner plate](#)
- *[D101-00-\(6 or 8\)-W-B11W 1/8 or 1/4 RPT Dist Block](#)
- Lubricator
- L1000-(6,8)-W Lubricator(1/8 or 1/4 ports)
- *[B110-W Wall mount Joiner Plate](#)
- *[C1000-J100-W Plain Joiner plate](#)
- *[D101-00-\(6 or 8\)-W-B11W 1/8 or 1/4 RPT Dist Block](#)
- A100-(6,8,10)-W end plate port set (1/8, 1/4, or 3/8 ports)

* = select option for this station

Add after the port code for:
 Nothing = Rpt or BSPT ports
 "N" = NPT ports
 "G" = BSPP ports
 Example:
 F1000-6-W 1/8 Rpt Filter
 F1000-8N-W 1/4" NPT Filter
 F1000-8G-W 1/4 BSPP Filter

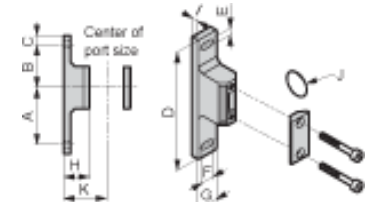

B110-W

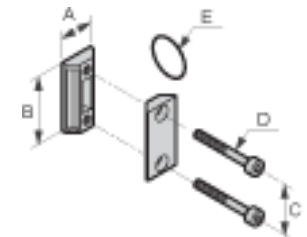

C1000-J100-W

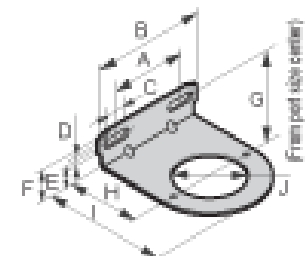

B130

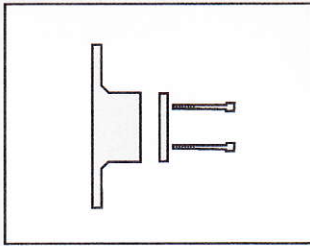

Bracket Standard white series

B-W/B Series

Joiner Standard white series

J-W Series



Dimensions and applications

T type bracket set

- Model no.: B110-W·B310-W·B410-W·B810-W
- Applications

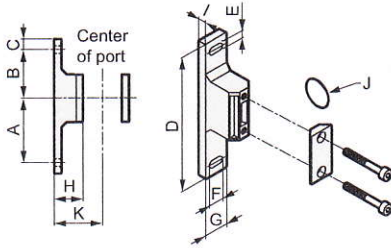

Note: Select B410-W when using the 3000-W Series and 4000-W Series combined.

Model no.	Applicable model	A	B	C	D	E	F	G	H	I	J	K
B110-W	1000 Series	45	35	10	100	5.5	7.5	16	25	7.5	JASO-2013	40
B310-W	2000 Series	60	45	10	125	7	14	22	27	7	JISB2401-P21	45
	3000 Series											
B410-W	4000 Series	60	45	10	125	7	14	22	37	7	JISB2401-P21	55
B810-W	6000 Series	70	50	15	150	9	14	27	37	8	AS568-127	65
	8000 Series											

C type bracket

- Model no.: B120·B220·B320·B420·B620·B820
- Attachment: BW

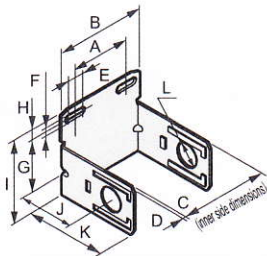

- Applications



Model no.	Applicable model	A	B	C	D	E	F	G	H	I	J	K	L
B120	1000 Series	44	68	40	t2.0	10	6.5	35	8.5	61.5	40	60	ø19.5
B220	2000 Series	28	54	50	t2.3	10	7	33	8	63	45	69	17.3
B320	3000 Series	34.5	67	63	t2.3	16.5	7	45	9	75.5	45	69	ø21.7
B420	4000 Series	55	84	80	t2.3	14.0	7	45	9	75.5	55	79	ø21.7
B620	6000 Series	68	104	90	t2.3	16	9	54	11	97.5	60	97	ø35
B820	8000 Series	68	104	100	t2.3	16	9	50	11	93.5	65	102	ø35

L type bracket

- Model no.: B130·B230·B330·B430
- Attachment: B3W

Loosen the mounting nut to remove the knob. After inserting L type bracket, fix the bracket by the mounting nut. Press the knob in manually after fixing. Refer to page 15 for the details.

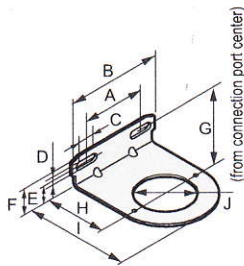

- Applications



Model no.	Applicable model	A	B	C	D	E	F	G	H	I	J	Other
B130	1000 Series	44	68	10	6.5	16	24.5	45	40	59	ø26.5	
B230	2000 Series	28	54	10	7	18	26	52	45	69	38	
B330	3000 Series	34.5	67	16.5	7	17.5	26	58 (63.5)	45	76	ø40	Values in () are for W3000·3100
B430	4000 Series	55	84	14	7	17.5	26	58	55	94	ø47	
	6000 Series											

Joiner set

- Model no.: C1000-J100-W
C4000-J400-W
C8000-J800-W

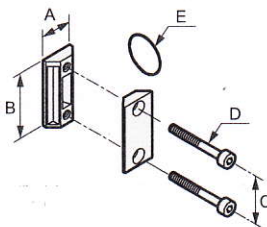

- Applications



Model no.	Applicable model	A	B	C	D	E
C1000-J100-W	1000 Series	10	36	26	M3.5	JASO-2013
C4000-J400-W	2000 Series	21	44	32	M5	JIS B2401-P21
	3000 Series					
	4000 Series					
C8000-J800-W	6000 Series	26	65	50	M6	AS568-127
	8000 Series					

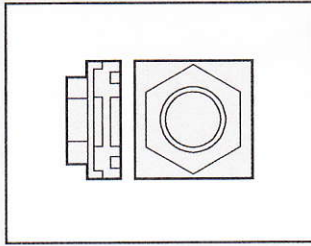

Piping adapter standard white series

A100/A400/A800-W Series

Port size: 1/8 to 1



Dimensions and applications

Piping adaptor set

- Model no.: A100-6, 8, 10-W
A400-8, 10, 15, 20-W
A800-20, 25, 32-W

● Applications

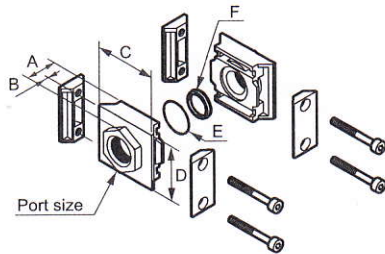

Model no.	Port size	Applicable model	A	B	C	D	E (O-ring)	F (Gasket)	Other
A100-6*-W	1/8	1000 Series	21.5	13.5	40	36	JASO-2013 1 programs	1 programs	-
A100-8*-W	1/4								
A100-10*-W	3/8								
A400-8*-W	1/4	2000 3000 Series	20	6 (11) {20}	50	45	JISB2401 P21 1 programs	1 programs	Numbers in () are for 3/4 Numbers in { } are for 1
A400-10*-W	3/8								
A400-15*-W	1/2								
A400-20*-W	3/4								
A400-25*-W	1								
A800-20*-W	3/4	6000 8000 Series	35 (38)	15 (18)	81	66	AS568-127 1 programs	1 programs	Numbers in () are for 1 1/4
A800-25*-W	1								
A800-32*-W	1 1/4								

* Blank: Rc thread/N: NPT thread/G: G thread

Piping adaptor set with T type bracket

- Model no.: A100-6, 8, 10-W-B11W
A400-8, 10, 15-W-B31W
A400-8, 10, 15, 20-W-B41W
A800-20, 25, 32-W-B81W
(T type bracket)

● Applications

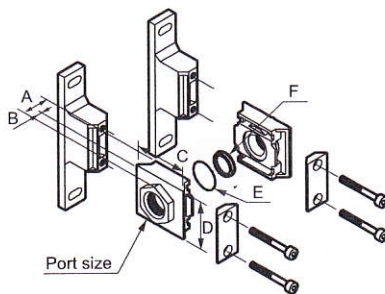

Model no.	Port size	Applicable model	A	B	C	D	E (O-ring)	F (Gasket)	Other
A100-6*-W-B11W	1/8	1000 Series	21.5	13.5	40	36	JASO-2013 1 programs	1 programs	-
A100-8*-W-B11W	1/4								
A100-10*-W-B11W	3/8								
A400-8*-W-B31W	1/4	2000 3000 Series	20	6 (11) {20}	50	45	JISB2401 P21 1 programs	1 programs	Numbers in () are for 3/4 Numbers in { } are for 1
A400-10*-W-B31W	3/8								
A400-15*-W-B31W	1/2								
A400-8*-W-B41W	1/4								
A400-10*-W-B41W	3/8								
A400-15*-W-B41W	1/2	4000 Series	20 (25) {34}	6 (11) {20}	50	45	JISB2401 P21 1 programs	1 programs	Numbers in () are for 3/4 Numbers in { } are for 1
A400-20*-W-B41W	3/4								
A400-25*-W-B41W	1								
A800-20*-W-B81W	3/4	6000 8000 Series	35 (38)	15 (18)	81	66	AS568-127 1 programs	1 programs	Numbers in () are for 1 1/4
A800-25*-W-B81W	1								
A800-32*-W-B81W	1 1/4								

* Blank: Rc thread/N: NPT thread/G: G thread

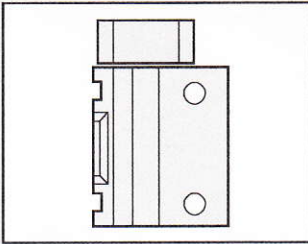

L piping adaptor White Series

A101/A401/A801-W Series

Port size: 1/8 t 1



Specifications

Descriptions	A101-W	A401-W Note 1	A801-W
Working fluid	Compressed air		
Max. working pressure MPa	1.0		
Withstanding pressure MPa	1.5		
Port size Rc, PT,	1/8, 1/4	1/4, 3/8, 1/2	3/4, 1
Working temperature °C	5 to 60		
Product weight kg	0.045	0.13	0.4

Note 1: A401-W can be connected to both 3000-W Series and 4000-W Series.

How to order

A101 - 6 - W - B11W

A Model no.

(White type)

B Port size

C Port thread type

D T type bracket

Symbol	Descriptions				
A Model no.					
A101	L type piping adaptor				
A401	L type piping adaptor				
A801	L type piping adaptor				
B Port size					
		A101	A401	A801	
6	1/8	●			
8	1/4	●	●		
10	3/8		●		
15	1/2		●		
20	3/4			●	
25	1			●	
C Port thread type					
Blank	Rc thread				
N	NPT thread				
G	G thread				
D T bracket					
Blank	None	Note 1	●	●	●
B11W	For 1000 Series		●		
B31W	For 2000 Series For 3000 Series			●	
B41W	For 4000 Series			●	
B81W	For 6000 Series For 8000 Series				●

- Applicable models
- A101-6, 8-W
..... 1000-W Series
- A401-8, 10, 15-W
..... 2000, 3000, 4000-W Series
- A801-20, 25-W
..... 6000, 8000-W Series

⚠ Cautions for model No. selection

Note 1: Joiner set (joiner, bolt, O ring) and 1 gasket included.

L type piping adaptor

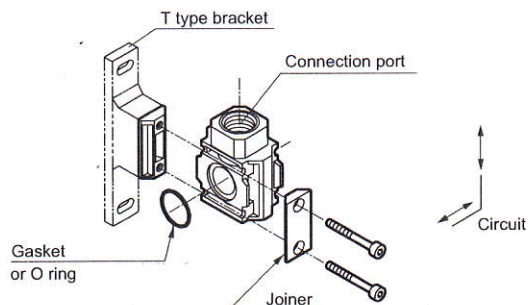

● Applications



Note: Insert the fitting for replacement vertically until it reaches the back. Insert the O ring when mounting on the primary side for the air flow, and insert the gasket when mounting on the secondary side.

Note: Refer to the next page for dimensions.

Piping adaptor

Dimensions 

● A101-W

● A401-W

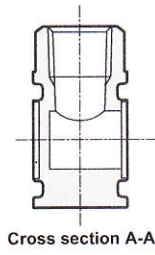
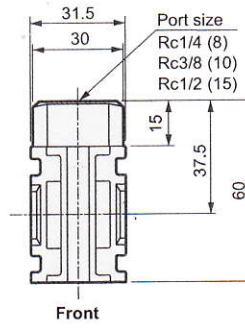
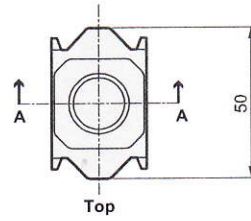
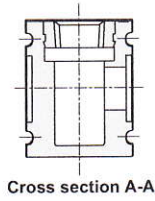
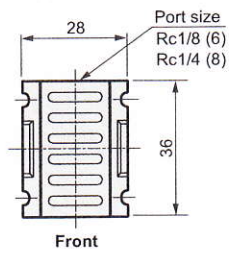
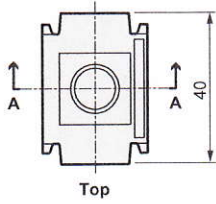

● A801-W

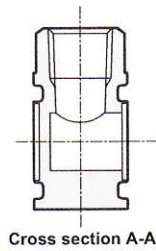
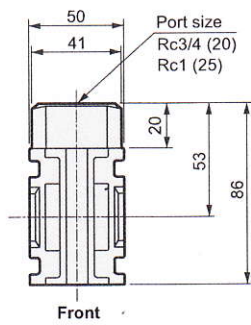
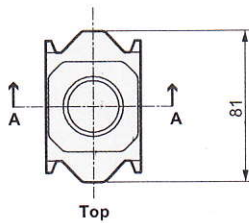

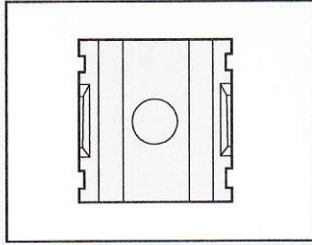

Distributor Standard white series

D101/D401/D801/D300-W Series

Applicable for pipe branching.

Port size: 1/8 to 1

JIS symbol

Rc1/4	Rc3/8
1/4	Rc1/4 3/8
(Rc3/8)	Rc
Rc1/4	Rc3/8



Specifications

Descriptions	D101-00-W	D401-00-W	D801-00-W	D300-W
Working fluid	Compressed air			
Max. working pressure MPa	1.0			
Withstanding pressure MPa	1.5			
No. of branch ports	1			4
Port size Rc, PT,	1/8, 1/4	1/4, 3/8, 1/2	3/4, 1	1/4, 3/8
Working temperature °C	5 to 60			
Product weight kg	0.045	0.13	0.35	0.26

How to order

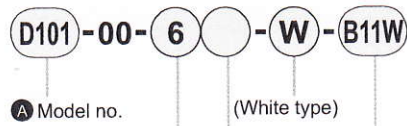

Symbol	Descriptions
A Model no.	
D101	For 1000 Series
D401	For 2000, 3000, 4000 Series
D801	For 6000, 8000 Series

B Port size		D101	D401	D801
6	1/8	●		
8	1/4	●	●	
10	3/8		●	
15	1/2		●	
20	3/4			●
25	1			●

C Port thread type	
Blank	Rc thread
N	NPT thread
G	G thread

D T type bracket		D101	D401	D801
Blank	None	●	●	●
B11W	For 1000 Series	●		
B31W	For 2000 Series		●	
B41W	For 4000 Series		●	
B81W	For 6000 Series			●

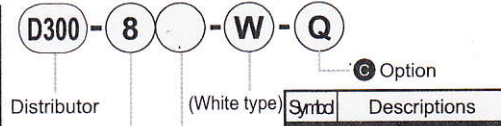

Symbol	Descriptions
A Port size	
8	1/4
10	3/8

B Port thread type	
Blank	Rc thread
N	NPT thread
G	G thread

C Option	
Blank	None
Q	1/4 blanking plug

⚠ Cautions for model No. selection

- Note 1: A joiner set (joiner/bolt/O-ring) and a gasket are attached as standard.
- Note 2: Consult with CKD for 2 way branch.
- Note 3: D401-W can be connected to both 3000-W and 4000-W series.

⚠ Cautions for model No. selection

- Note 1: When using with C3000-W, C4000-W, a joiner set C4000-J400-W, or T type bracket set B310-W or B410-W is required to connect.
- Note 2: Joiner set C4000-J400-W or T type bracket set should be ordered separately. (Refer to page 152)

How to install (D101-00-W, D401-00-W, D801-00-W)

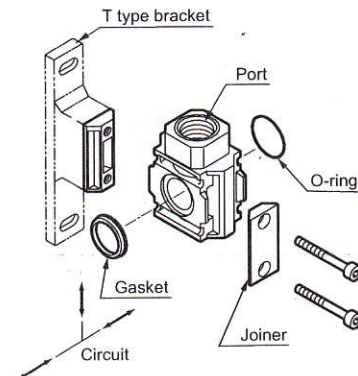

- Note 1: When installing at the primary side, insert an O ring, while installing at the secondary side, insert a gasket.
- Note 2: When inserting O ring and gasket to assemble, O ring and gasket must not be folded.

Example (D101-00-W, D401-00-W, D801-00-W)



Distributor

Dimensions

Dimensions

● D101-00-W

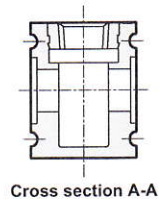
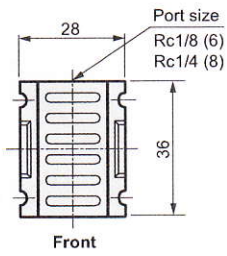
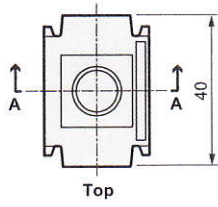

● D401-00-W

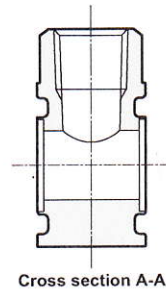
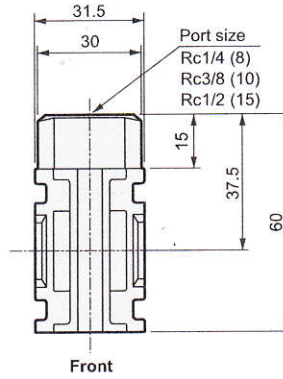
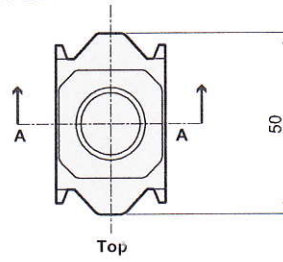

● D801-00-W

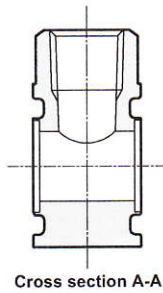
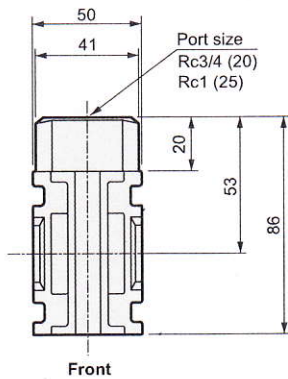
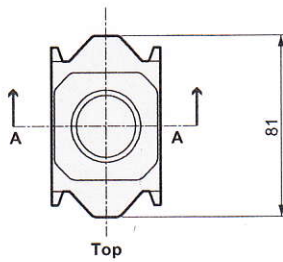

● D300-W

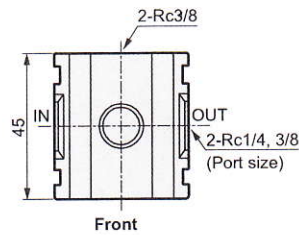
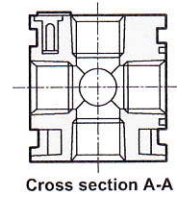
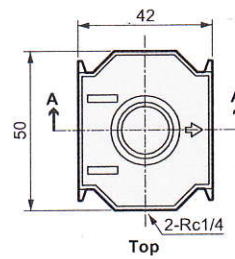

How to order

- For FRL 1000 Series

V1000 - **6** - **W** - - - **A6W**
(White type)

- For FRL 3000, 4000 Series

V3000 - **8** - **W** - - - **A6W**
(White type)

A Model no.

B Port size

C Port thread type

D Option

E Displayed unit

F Attachment

A Model no.

V	V
1	3
0	0
0	0
0	0

Symbol	Descriptions		
B Port size			
6	Rc1/8	●	
8	Rc1/4	●	●
10	Rc3/8		●
15	Rc1/2		●
C Port thread type			
Blank	Rc thread	●	●
N	NPT thread	●	●
G	G thread	●	●
D Option			
Blank	Standard flow (left to right)	●	●
X1	In/out reverse flow (right to left)	●	●
E Displayed unit			
Blank	MPa display, Rc thread	●	●
J1	MPa display, NPT, G thread	●	●
F Attachment Note 1, Note 2			
Blank	No attachments	●	●
A6*W	1/8 piping adaptor set	●	
A8*W	1/4 piping adaptor set	●	●
A10*W	3/8 piping adaptor set	●	●
A15*W	1/2 piping adaptor set		●
A20*W	3/4 piping adaptor set		●
BW	C type bracket	●	●
S	Silencer	●	●
* Adaptor thread type			
Blank	Rc thread	●	●
N	NPT thread	●	●
G	G thread	●	●

⚠ Cautions for model No. selection

Note 1: The piping adaptor set and C bracket cannot be used together.
 Note 2: A joiner set is attached with the piping adaptor set.

⚠ Select the reverse regulator (R*100-W) or reverse filter regulator (W*100-W) when installing the V*000-W onto the primary side of the regulator or filter regulator.

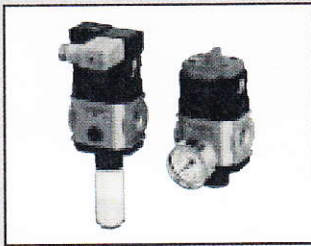

Slow start valve

V3301/V3321 Series

To maintain safety at starting and stopping

- Port size: Rc1/4 to Rc1/2

JIS symbol

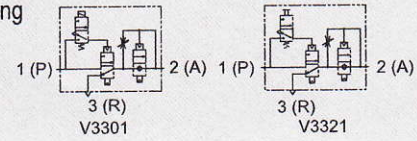

- Refrigerating type dryer
- Desiccant type dryer
- High polymer membrane dryer
- Air filter
- Auto. drain / others
- F.R.L. (Module unit)
- F.R.L. (Separate)
- Compact F.R.
- Precise regulator
- F.R.L. (Related products)
- Clean F.R.
- Electro pneumatic regulator
- Air booster
- Speed control valve
- Silencer
- Check valve / others
- Joint / tube
- Vacuum filter
- Vacuum regulator
- Suction plate
- Magnetic spring buffer
- Mechanical pressure SW
- Electronic pressure SW
- Contact / close contact cont. SW
- Air sensor
- Pressure SW for coolant
- Small flow sensor
- Small flow controller
- Flow sensor for air
- Flow sensor for water
- Total air system
- Total air system (Gamma)
- Ending

Specifications

Descriptions		V3301/V3321		
Operating method		Pilot operated soft spool valve		
Working fluid		Compressed air (excluding ultra dry compressed air) Note 1		
Working pressure range MPa		0.2 to 1.0		
Withstanding pressure MPa		1.5		
Ambient temperature range °C		5 to 60		
Port size	1 (P)/2 (A) port	Rc1/4	Rc3/8	Rc1/2
	3 (R) port	Rc3/8		
	Gauge port	Rc1/4		
Effective sectional area mm ²	Low speed air supply	6		
	High speed air supply	40	64	76
High speed exhaust	High speed exhaust	50	74	78
	Response time	0.2sec or less		
Lubrication		Oil-free Note 2		
Weight g		V3301: 635 V3321: 515		
Solenoïd valve specifications		V3301		
Rated voltage V		100 AC (50/60Hz)	200 AC (50/60Hz)	24DC
Starting current A		0.076/0.058	0.038/0.030	0.092
Holding current A		0.038/0.029	0.019/0.015	
Power consumption W		2.2/1.7	2.2/1.7	2.2
Temperature rises K		40 or less		
Voltage fluctuation range		± 10%		
Insulation class		Class B		
Electric connection		Grommet lead wire, terminal box		

Note 1: Consult with CKD when using ultra dry air.
 Note 2: Use the turbine oil Class 1 ISO VG32 if lubricated.

How to order

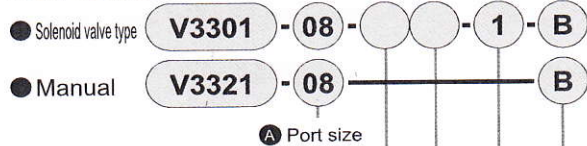

Symbol	Descriptions	
A Port size		
1 (P)/2 (A) port		
08	Rc1/4	
10	Rc3/8	
15	Rc1/2	
B Manual override		
Blank	Non-locking	
M1	Locking	
C Electric connection		
Blank	Grommet lead wire	
S	Grommet lead wire, surge suppressor	
B	Terminal box	
LS	Terminal box surge suppressor, light	
D Voltage		
1	100 VAC 50/60Hz	Standard
2	200 VAC 50/60Hz	
3	24 VDC	Option
4	12 VDC	
5	110 VAC 50/60Hz	
6	220 VAC 50/60Hz	
E Attached option		
Blank	Without attachment	
B	Bracket	
G49P	Pressure gauge (note)	
S	Silencer	

⚠ Note on model no. selection

Note: A pressure gauge with φ43, 0 to 1.0MPa range is attached.

- ⚠ Select the reverse regulator (R*100) or reverse filter regulator (W*100) when installing the V3301, V3321 onto the primary side of the regulator or filter regulator.

Dimensions

● V3301

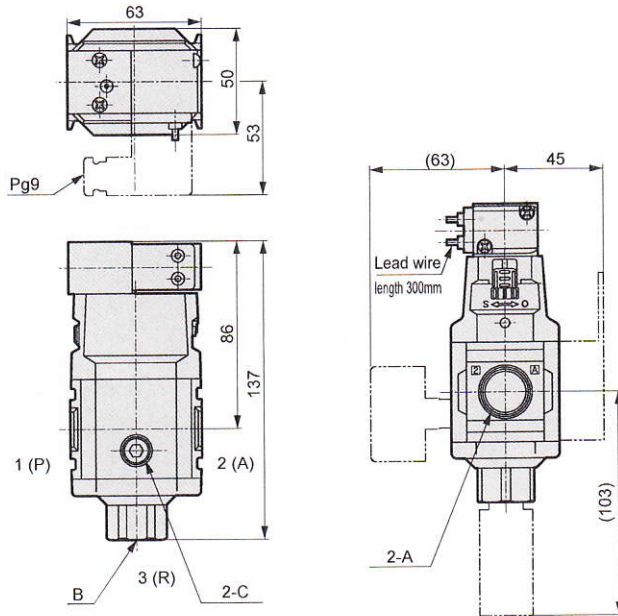

	A	B	C
V3301-08	Rc1/4		
V3301-10	Rc3/8	Rc3/8	Rc1/4
V3301-15	Rc1/2		

● V3321

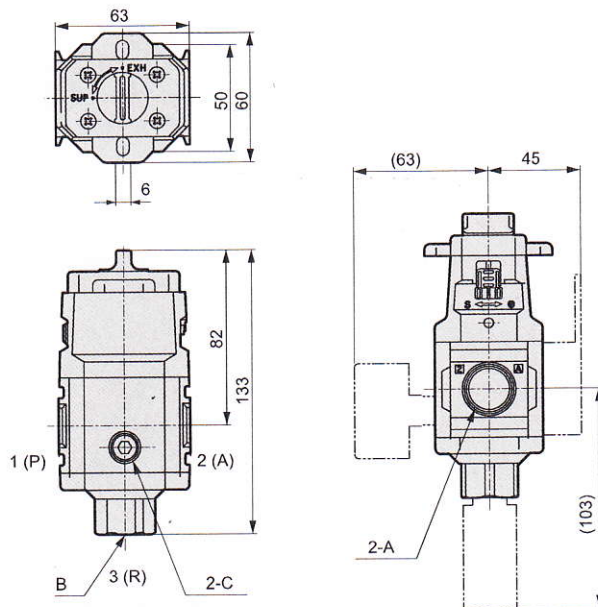

	A	B	C
V3321-08	Rc1/4		
V3321-10	Rc3/8	Rc3/8	Rc1/4
V3321-15	Rc1/2		

● Bracket: B320

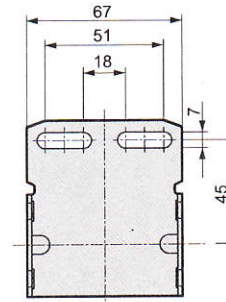

● Pressure gauge: G49D-8-P10

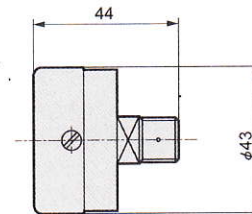

● Silencer: SLW-10A

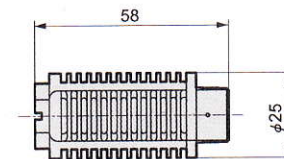

Refrigerating type dryer
Desiccant type dryer
High polymer membrane dryer
Air filter
Auto. drain / others
F.R.L. (Module unit)
F.R.L. (Separate)
Compact F.R.
Precise regulator
F.R.L. (Related products)
Clean F.R.
Electro pneumatic regulator
Air booster
Speed control valve
Silencer
Check valve / others
Joint / tube
Vacuum filter
Vacuum regulator
Suction plate
Magnetic spring buffer
Mechanical pressure SW
Electronic pressure SW
Contact / close contact conf. SW
Air sensor
Pressure SW for coolant
Small flow sensor
Small flow controller
Flow sensor for air
Flow sensor for water
Total air system
Total air system (Gamma)
Ending

Standard Series
F.R.L. unit

Air Filter Series

How to order

How to order

F1000 - **6** - **W** - **Z** - **A6W**

A Model no.

B Port size

C Port thread type

D Option

E Displayed unit

F Piping adaptor set (included)

G Bracket (attached)

* Refer page 9 for an explanation of the options.

A Model no.					
F	F	F	F	F	F
1	2	3	4	6	8
0	0	0	0	0	0
0	0	0	0	0	0
0	0	0	0	0	0

Symbol	Descriptions						
B Port size							
6	1/8	●					
8	1/4	●	●				
10	3/8		●	●			
15	1/2				●		
20	3/4					●	●
25	1					●	●
C Port thread type		Note 1					
Blank	Rc thread	●	●	●	●	●	●
N	NPT thread	●	●	●	●	●	●
G	G thread	●	●	●	●	●	●
D Option		Note 2					
Drainage	Blank	With manual drain cock	●	●	●	●	●
	F	Automatic drain with manual override (NO type)			●	●	●
	F1	Automatic drain with manual override (NC type)	●	●	●	●	●
	FF	Large exhaust automatic drain with manual override (NO type)					●
Note 3	FF1	Large exhaust automatic drain with manual override (NO type)					●
	Blank	Polycarbonate bowl	●	●	●	●	●
Bowl material	Z	Nylon bowl	●	●	●	●	●
	M	Metal bowl			●	●	●
	M1	Metal bowl with manual drain cock			●	●	●
Element	Blank	5µm	●	●	●	●	●
	Y	0.3µm (submicron)			●	●	●
Differential pressure detection	Blank	Without differential pressure detection port	●	●	●	●	●
	Q	With differential pressure detection port (Rc1/4)					●
Flow Direction	Blank	Standard flow (left to right)	●	●	●	●	●
	X1	Reverse flow (right to left)	●	●	●	●	●
E Displayed unit							
Blank	MPa display, Rc thread	●	●	●	●	●	●
J1	MPa display, NPT, G thread	●	●	●	●	●	●
F Piping adaptor set (included)		Note 4 pages 155 to 157 Note 5					
Blank	Not attached	●	●	●	●	●	●
A6*W	1/8 piping adaptor set	●					
A8*W	1/4 piping adaptor set		●	●			
A10*W	3/8 piping adaptor set		●	●	●		
A15*W	1/2 piping adaptor set			●	●		
A20*W	3/4 piping adaptor set					●	●
A25*W	1 piping adaptor set						●
A32*W	1 1/4 piping adaptor set						●
* Adaptor thread type							
Blank	Rc thread	●	●	●	●	●	●
N	NPT thread	●	●	●	●	●	●
G	G thread	●	●	●	●	●	●
G Bracket (attached)		Page 152					
Blank	Not attached	●	●	●	●	●	●
BW	C type bracket	●	●	●	●	●	●

⚠ Cautions for model No. selection

- Note 1: When G threads or NPT threads are selected, the IN, OUT, gauge port, and drainage discharge port (metal bowl automatic drain) are the target, as are attachments P and V.
- Note 2: Select the option from drain exhaust, bowl material and differential pressure detection. When selecting options for several items, list options in order from the top.
- Note 3: Refer to page 12 for working conditions of the automatic drain.
- Note 4: The piping adaptor set and C bracket cannot be used together.
- Note 5: A joiner set is attached with the piping adaptor set.

Oil Mist Filter Series

How to order

How to order

M1000 - **6** - **W** - **S** - **A6W** -

A Model no.

B Port size

C Port thread type

D Option

E Displayed unit

F Piping adaptor set (included)

G Bracket (attached)

* Refer top page 9 for an explanation of the options.

A Model no.					
M	M	M	M	M	M
1	2	3	4	6	8
0	0	0	0	0	0
0	0	0	0	0	0
0	0	0	0	0	0

Symbol	Descriptions						
B Port size							
6	1/8	●					
8 Note 1	1/4	●	●	●	●		
10	3/8		●	●	●		
15	1/2			●			
20	3/4					●	●
25	1					●	●
C Port thread type Note 2							
Blank	Rc thread	●	●	●	●	●	●
N	NPT thread	●	●	●	●	●	●
G	G thread	●	●	●	●	●	●
D Option Note 3							
Drainage Note 4, Note 5	Blank	With manual drain cock	●	●	●	●	●
	F1	Automatic drain with manual override (NC type)	●	●	●	●	●
Bowl material	Blank	Polycarbonate bowl	●	●	●	●	●
	Z	Nylon bowl	●	●	●	●	●
	M	Metal bowl Note 6			●	●	●
Mantle (element)	M1	Metal bowl with manual drain cock	●	●	●	●	●
	Blank	M type (nominal 0.01 μm; remaining oil 0.01 mg/m ³)	●	●	●	●	●
	S	S type (0.3 μm; remaining oil 0.5 mg/m ³)	●	●	●	●	●
Differential pressure detection	X Note 7	X type (deodorization; remaining oil 0.003mg/m ³)	●	●	●	●	●
	Blank	Without differential pressure detection port	●	●	●	●	●
	Q	With differential pressure detection port (Rc1/4)				●	●
Differential pressure indicator Q1 Note 6 , Note 7	Blank	Without differential pressure indicator	●	●	●	●	●
	Q1	With differential pressure indicator			●		
Flow direction	Blank	Standard flow (left to right)	●	●	●	●	●
	X1	Reverse flow (right to left)	●	●	●	●	●
E Displayed unit							
Blank	MPa display, Rc thread	●	●	●	●	●	●
J1	MPa display, NPT, G thread	●	●	●	●	●	●
F Piping adaptor set (included) Note 8, 9 pages 155 to 157							
Blank	Not attached	●	●	●	●	●	●
A6*W	1/8 piping adaptor set	●					
A8*W	1/4 piping adaptor set	●	●	●	●		
A10*W	3/8 piping adaptor set	●	●	●	●		
A15*W	1/2 piping adaptor set		●	●	●		
A20*W	3/4 piping adaptor set				●	●	●
A25*W	1 piping adaptor set					●	●
A32*W	1 1/4 piping adaptor set					●	●
* Adaptor thread type							
Blank	Rc thread	●	●	●	●	●	●
N	NPT thread	●	●	●	●	●	●
G	G thread	●	●	●	●	●	●
G Bracket (attached) Page 152							
Blank	Not attached	●	●	●	●	●	●
BW	C type bracket	●	●	●	●	●	●

⚠ Cautions for model No. selection

Note 1: Differential indicator option "Q1" is not available for port size "B"

Note 2: When G threads or NPT threads are selected, the IN, OUT, gauge port, and drainage discharge port (metal bowl automatic drain) are the target, as are attachments P and V.

Note 3: Select options for each drainage discharge, bowl material and differential pressure detection.

When selecting options for several items, list options in order from the top.

Note 4: N.O. automatic drain cannot be selected.

Note 5: Refer to page 12 for working conditions of the automatic drain.

Note 6: Option for differential indicator "Q1" is not available for bowl material "M"

Note 7: Combination with option F1 or "Q1" with differential pressure indicator is not possible.

Note 8: The piping adapter set and C bracket cannot be used together.

Note 9: A joiner set is attached with the piping adapter set.

Super Oil Mist Filter Series

How to order

How to order

MX1000 - **6** - **W** - **Z** - **A6W**

A Model no.

B Port size

C Port thread type

D Port thread type

E Displayed unit

F Piping adaptor set (included)

* Refer top page 9 for an explanation of the options.

A Model no.				
M	M	M	M	M
X	X	X	X	X
1	3	4	6	8
0	0	0	0	0
0	0	0	0	0

G Bracket (attached)

Symbol	Descriptions					
B Port size						
6	1/8	●				
8	1/4	●	●	●		
10	3/8		●	●		
15	1/2			●		
20	3/4				●	●
25	1				●	●
C Port thread type Note 1						
Blank	Rc thread	●	●	●	●	●
N	NPT thread	●	●	●	●	●
G	G thread	●	●	●	●	●
D Option Note 2						
Drainage	Blank	With manual drain cock	●	●	●	●
	F1 Note 3, Note 4	Automatic drain with manual override (NC type)	●	●	●	●
Bowl material	Blank	Polycarbonate bowl	●	●	●	●
	Z	Nylon bowl	●	●	●	●
	M	Metal bowl		●	●	●
	M1	Metal bowl with manual drain cock		●	●	●
Differential pressure detection	Blank	Without differential pressure detection port	●	●	●	●
	Q	With differential pressure detection port (Rc1/4)				●
Flow Direction	Blank	Standard flow (left to right)	●	●	●	●
	X1	Reverse flow (right to left)	●	●	●	●
E Displayed unit						
Blank	MPa display, Rc thread	●	●	●	●	●
J1	MPa display, NPT, G thread	●	●	●	●	●
F Piping adaptor set (included) Note 5 pages 155 to 157 Note 6						
Blank	Not attached	●	●	●	●	●
A6*W	1/8 piping adaptor set	●				
A8*W	1/4 piping adaptor set	●	●	●		
A10*W	3/8 piping adaptor set	●	●	●		
A15*W	1/2 piping adaptor set		●	●		
A20*W	3/4 piping adaptor set			●	●	●
A25*W	1 piping adaptor set				●	●
A32*W	1 1/4 piping adaptor set				●	●
* Adaptor thread type						
Blank	Rc thread	●	●	●	●	●
N	NPT thread	●	●	●	●	●
G	G thread	●	●	●	●	●
G Bracket (attached) Page 152						
Blank	Not attached	●	●	●	●	●
BW	C type bracket	●	●	●	●	●

⚠ Cautions for model No. selection

Note 1: When G threads or NPT threads are selected, the IN, OUT, gauge port, and drainage discharge port (metal bowl automatic drain) are the target, as are attachments P and V.

Note 2: Select options for each drainage discharge, bowl material and differential pressure detection.

When selecting options for several items, list options in order from the top.

Note 3: N.O. automatic drain cannot be selected.

Note 4: Refer to page 12 for working conditions of the automatic drain.

Note 5: Piping adaptor set and C type bracket cannot be used together.

Note 6: A joiner set is attached with the piping adapter set.

Filter·Regulator series

How to order

How to order

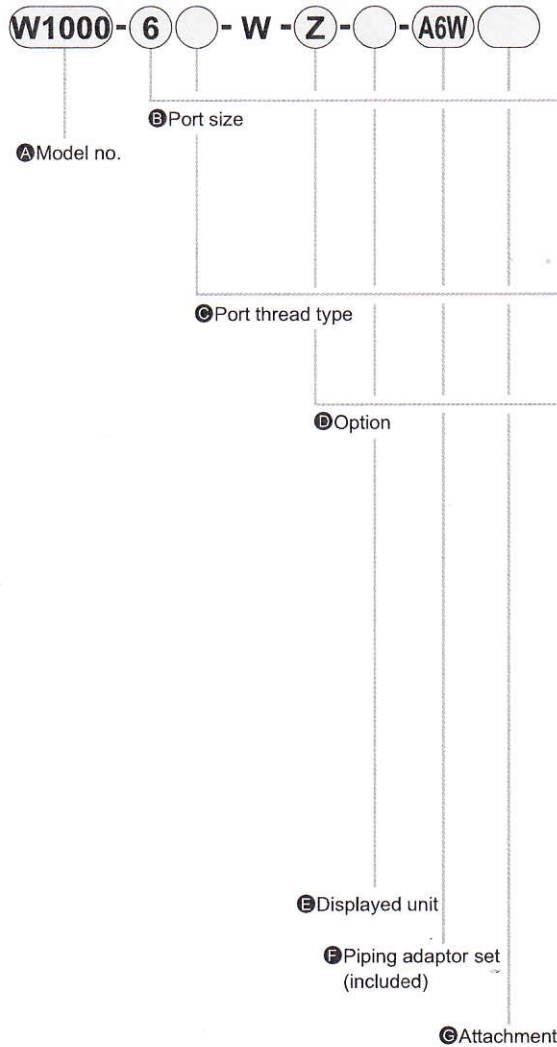

* Refer page 9 for an explanation of the options.

A Model no.				
W	W	W	W	W
1	2	3	4	8
0	0	0	0	0
0	0	0	0	0

Symbol	Descriptions					
B Port size						
6	1/8	●				
8	1/4	●	●	●	●	
10	3/8		●	●	●	
15	1/2				●	
20	3/4					●
25	1					●

C Port thread type		Note 1				
Blank	Rc thread	●	●	●	●	●
N	NPT thread	●	●	●	●	●
G	G thread	●	●	●	●	●

D Option		Note 2				
Drainage	Blank	With manual drain cock	●	●	●	●
	F	Automatic drain with manual override (NO type)				
	F1	Automatic drain with manual override (NC type)	●	●	●	●
	FF	Large exhaust automatic drain with manual override (NO type)				●
Note 3	FF1	Large exhaust automatic drain with manual override (NO type)				●
	Blank	Polycarbonate bowl	●	●	●	●
Bowl material	Z	Nylon bowl	●	●	●	●
	M	Metal bowl			●	●
	M1	Metal bowl with manual drain cock			●	●
Element	Blank	5µm	●	●	●	●
	Y	0.3µm (submicron) Note 4			●	●
Pressure Range	Blank	0.05 to 0.85MPa	●	●	●	●
	L	0.05 to 0.35MPa Note 5	●	●	●	●
Relief	Blank	With relief mechanism	●	●	●	●
	N	Non-relief type	●	●	●	●
Pressure gauge	Blank	Standard pressure gauge (G401-W)	●	●	●	●
	T	Without pressure gauge (gauge port (Rc1/4) assembled sealed)	●	●	●	●
	T8	Pressure gauge attachable (gauge port (Rc1/4) assembled open)	●	●	●	●
	T6	Compatibility with digital pressure sensor PPX Note 6	●	●	●	●
	R1	Pressure switch with display PPD assembled Note 7	●	●	●	●
Flow Direction	Blank	Standard flow (left to right)	●	●	●	●
	X1	Reverse flow (right to left)	●	●	●	●

E Displayed unit						
Blank	MPa display, Rc thread	●	●	●	●	●
J1	MPa display, NPT, G thread	●	●	●	●	●

F Piping adaptor set (included)		Note 8, 9 Pages 155 to 157				
Blank	Not attached	●	●	●	●	●
A6*W	1/8 piping adaptor set	●	●	●	●	●
A8*W	1/4 piping adaptor set	●	●	●	●	●
A10*W	3/8 piping adaptor set	●	●	●	●	●
A15*W	1/2 piping adaptor set		●	●	●	●
A20*W	3/4 piping adaptor set				●	●
A25*W	1 piping adaptor set					●
A32*W	1 1/4 piping adaptor set					●

* Adaptor thread type						
Blank	Rc thread	●	●	●	●	●
N	NPT thread	●	●	●	●	●
G	G thread	●	●	●	●	●

G Attachment		Note 10 Page 152, 198				
Blank	Not attached	●	●	●	●	●
BW	C type bracket	●	●	●	●	●
B3W Note 7	L type bracket Note 11	●	●	●	●	●
G45P	G45D-8-P10 (L: G45D-8-P04)	●	●	●	●	●
G49P	G49D-8-P10 (L: G49D-8-P04)	●	●	●	●	●
G59P	G59D-8-P10 (L: G59D-8-P04)	●	●	●	●	●
G40P	G40D-8-P10 (L: G40D-8-P04)	●	●	●	●	●
G50P	G50D-8-P10 (L: G50D-8-P04)	●	●	●	●	●
G41P	G41D-8-P10 (L: G41D-8-P04)	●	●	●	●	●
G52P	G52D-8-P10 (L: G52D-8-P10)	●	●	●	●	●
R2 Note 5	Digital pressure sensor: PPX-R10N-6M	●	●	●	●	●

⚠ Cautions for model No. selection

- Note 1: G threads and NPT threads are available for IN, OUT, gauge port and drain discharge port (metal bowl with automatic drain).
- Note 2: Select options per drainage, bowl material, element, and regulator sections.
When selecting options for several items, list options in order from the top.
- Note 3: Refer to page 12 for working conditions of the automatic drain.
- Note 4: Refer to page 87 for max. flow rate of option "Y".
- Note 5: Pressure gauge display range will be 0 to 0.4 MPa for option "L".
- Note 6: When option "T6" is selected, only "blank" or "R2" is selected for the (G) pressure gauge (enclosed). The digital pressure sensor PPX mounting port (Rc1/8) is assembled ventilated.
- Note 7: Out put type will be NPN transistor output. Consult with CKD if PNP transistor output is required.
- Note 8: Piping adapter set and C bracket cannot be used together.
- Note 9: A joiner set is attached with the piping adapter set.
- Note 10: If NPT is selected for the "C" piping thread type, a NPT pressure gauge is enclosed. If Rc or G thread is selected, an R thread pressure gauge is enclosed.
- Note 11: Refer to Section (2. Regulator), in "⚠ PRECAUTIONS For Installation and Adjustment" (page 15) for details on mounting the L-type bracket.

Regulator Series

How to order

How to order

* Refer top page 9 for an explanation of the options.



A Model no.

B Port size

C Port thread type

D Option

E Displayed unit

A Model no.					
R 1	R 2	R 3	R 4	R 6	R 8
0	0	0	0	0	0
0	0	0	0	0	0
0	0	0	0	0	0

F Piping adaptor set (included)

Symbol	Descriptions	R 1	R 2	R 3	R 4	R 6	R 8
B Port size							
6	1/8	●					
8	1/4	●	●	●	●		
10	3/8		●	●	●		
15	1/2				●		
20	3/4					●	●
25	1					●	●

C Port thread type

Note 1

Blank	Rc thread	R 1	R 2	R 3	R 4	R 6	R 8
Blank	Rc thread	●	●	●	●	●	●
N	NPT thread	●	●	●	●	●	●
G	G thread	●	●	●	●	●	●

D Option

Note 2

Pressure Range	Blank	0.05 to 0.85MPa	R 1	R 2	R 3	R 4	R 6	R 8
Range	L	0.05 to 0.35MPa Note 3	●	●	●	●	●	●
Relief	Blank	With relief mechanism	●	●	●	●	●	●
	N	Non-relief type	●	●	●	●	●	●
Pressure gauge	Blank	Standard pressure gauge (G401-W)	●	●	●	●	●	●
	T	Without pressure gauge (gauge port (Rc1/4) assembled sealed)	●	●	●	●	●	●
	T8	Pressure gauge attachable (gauge port (Rc1/4) assembled open)	●	●	●	●	●	●
	T6	Compatibility with digital pressure sensor PPX Note 4	●	●	●	●	●	●
Flow Direction	Blank	Standard flow (left to right)	●	●	●	●	●	●
	X1	Reverse flow (right to left)	●	●	●	●	●	●

E Displayed unit

Blank	MPa display, Rc thread	R 1	R 2	R 3	R 4	R 6	R 8
Blank	MPa display, Rc thread	●	●	●	●	●	●
J1	MPa display, NPT, G thread	●	●	●	●	●	●

F Piping adaptor set (Included)

Note 6, 7 pages 155 to 157

Blank	Not attached	R 1	R 2	R 3	R 4	R 6	R 8
Blank	Not attached	●	●	●	●	●	●
A6*W	1/8 piping adaptor set	●					
A8*W	1/4 piping adaptor set	●	●	●	●		
A10*W	3/8 piping adaptor set	●	●	●	●		
A15*W	1/2 piping adaptor set		●	●	●		
A20*W	3/4 piping adaptor set				●	●	●
A25*W	1 piping adaptor set					●	●
A32*W	1 1/4 piping adaptor set					●	●

* Adaptor thread type

Blank	Rc thread	R 1	R 2	R 3	R 4	R 6	R 8
Blank	Rc thread	●	●	●	●	●	●
N	NPT thread	●	●	●	●	●	●
G	G thread	●	●	●	●	●	●

G Attachment

Note 8 Page 152, 198

Blank	Not attached	R 1	R 2	R 3	R 4	R 6	R 8
Blank	Not attached	●	●	●	●	●	●
BW	C type bracket	●	●	●	●	●	●
B3W Note 5	L type bracket Note 9	●	●	●	●	●	●
B4W	B type bracket	●	●	●	●	●	●
G45P	G45D-8-P10 (L: G45D-8-P04)	●	●	●	●	●	●
G49P	G49D-8-P10 (L: G49D-8-P04)	●	●	●	●	●	●
G59P	G59D-8-P10 (L: G59D-8-P04)	●	●	●	●	●	●
G40P	G40D-8-P10 (L: G40D-8-P04)	●	●	●	●	●	●
G50P	G50D-8-P10 (L: G50D-8-P04)	●	●	●	●	●	●
G41P	G41D-8-P10 (L: G41D-8-P04)	●	●	●	●	●	●
G52P	G52D-8-P10 (L: G52D-8-P10)	●	●	●	●	●	●
R2 Note 4	Digital pressure sensor: PPX-R10N-6M	●	●	●	●	●	●

⚠ Cautions for model No. selection

Note 1: G and NPT threads are available for IN, OUT, and gauge ports.

Note 2: When selecting options for several items, list options in order from the top.

Note 3: Pressure gauge display range will be 0 to 0.4 MPa for option "L".

Note 4: When option "T6" is selected, only "blank" or "R2" is selected for the (G) pressure gauge (enclosed). The digital pressure sensor PPX mounting port (Rc1/8) is assembled ventilated.

Note 5: Output type will be NPN transistor output. Consult with CKD if PNP transistor output is required.

Note 6: The piping adapter set and C bracket cannot be used together.

Note 7: A joiner set is attached with the piping adapter set.

Note 8: If NPT is selected for the "C" piping thread type, a NPT pressure gauge is enclosed. If Rc or G thread is selected, an R thread pressure gauge is enclosed.

Note 9: Refer to Section 2, Regulator, in "⚠ PRECAUTIONS for Installation and Adjustment" (page 15) for details on mounting the L-type bracket.

How to order



* Refer top page 9 for an explanation of the options.

A Model no.			
L	L	L	L
1	3	4	8
0	0	0	0
0	0	0	0
0	0	0	0

A Model no.

B Port size

C Port thread type

D Option

E Displayed unit

F Piping adaptor set (included)

⚠ Cautions for model No. selection

- Note 1: G and NPT threads are available for IN, OUT.
- Note 2: When selecting options for several items, list options in order from the top.
- Note 3: The adjusting dome is made of polycarbonate for a nylon bowl or metal bowl. Consult with CKD if a different material is required.
- Note 4: Have a choice drain discharge option "C" or "F" and "F1" for option "M1".
- Note 5: The piping adapter set and C bracket cannot be used together.
- Note 6: A joiner set is attached with the piping adapter set.

Drainage and bowl material combination (how to order "D")

Option ● with float switch

G Bracket (attached)

Symbol	Descriptions	L1000	L3000	L4000	L8000
B Port size					
6	1/8	●			
8	1/4	●	●	●	
10	3/8		●	●	
15	1/2			●	
20	3/4				●
25	1				●

C Port thread type

Note 1

Blank	Rc thread	L1000	L3000	L4000	L8000
Blank	Rc thread	●	●	●	●
N	NPT thread	●	●	●	●
G	G thread	●	●	●	●

D Option

Note 2

Drain	Blank	No manual cock	L1000	L3000	L4000	L8000
Discharge	Blank	No manual cock	●	●	●	●
	C	With manual cock	●	●	●	●
Bowl	LL	With float switch		●	●	●
	Blank	Polycarbonate bowl	●	●	●	●
Material	Z	Nylon bowl	●	●	●	●
	M	Metal bowl		●	●	●
	M1	Metal bowl with manual drain cock Note 4		●	●	●
Flow Direction	Blank	Standard flow (left to right)	●	●	●	●
	X1	Reverse flow (right to left)	●	●	●	●

E Displayed unit

Blank	MPa display, Rc thread	L1000	L3000	L4000	L8000
Blank	MPa display, Rc thread	●	●	●	●
J1	MPa display, NPT, G thread	●	●	●	●

F Piping adaptor set (included)

Note 5, 6 pages 155 to 157

Blank	Not attached	L1000	L3000	L4000	L8000
Blank	Not attached	●	●	●	●
A6*W	1/8 piping adaptor set	●			
A8*W	1/4 piping adaptor set	●	●	●	
A10*W	3/8 piping adaptor set	●	●	●	
A15*W	1/2 piping adaptor set		●	●	
A20*W	3/4 piping adaptor set			●	●
A25*W	1 piping adaptor set				●
A32*W	1 1/4 piping adaptor set				●

* Adaptor thread type

Blank	RC thread	L1000	L3000	L4000	L8000
Blank	RC thread	●	●	●	●
N	NPT thread	●	●	●	●
G	G thread	●	●	●	●

G Bracket (attached)

Blank	Not attached	L1000	L3000	L4000	L8000
Blank	Not attached	●	●	●	●
BW	C type bracket	●	●	●	●

3000/4000/8000 Series			
Shape			
Material	Plastic bowl		Metal bowl
	Polycarbonate	Nylon	Aluminum
Lubricator L3000-W	LL	LLZ	LLM